

A Transceiver Designed For Intra-body Communication of Body Area Networks

Jing-Wu He¹ Yue-Ming Gao^{1,2} Sio Hang Pun^{1,3} Peng Un Mak^{1,3} Mang I Vai^{1,3}

¹ Fujian Key Laboratory of Medical Instrumentation & Pharmaceutical Technology, Fu Jian, CHINA

² College of Physics and Telecommunication Engineering, Fuzhou University, Fu Zhou, 350002, CHINA

³ Department of Electrical and Electronics Engineering, Faculty of Science and Technology, University of Macau, Macau SAR, CHINA

fzugym@163.com

ABSTRACT

The galvanic coupling intra-body communication (IBC) is a novel short distance information transmission method for Body Area Networks. It uses human body as the transmission media to realize data transmission and sharing among all the electronic devices scattered on, in or around the human body. It is especially suitable for information interactions for long term and continuous medical signal detections for human bodies for wearable/implanted medical devices.

Based on the principle analysis of the galvanic coupling IBC previously, this paper attempted to design a highly reliable and stable transceiver. The transmitter modulated the base band signal with 2CPFSK (2 continuous phase FSK) and converted it into alternating current signal suitable for human body transmission. The receiver collected the coupling voltage signal differentially, and then demodulated it. Finally, the transceiver completed the data transmission in the case of signal person and many people with finger-touching. It provided a successful experience for the development and practical application of IBC and Body Area Networks.

Keywords

intra-body communication, galvanic coupling, transceiver design, DDS

INTRODUCTION

Body Area Network (BAN) is a kind of network scattered across the human body, which consists of sensor nodes and a body host (or BAN coordinator). Each sensor can be attached on or implanted in the human body. Coordinator ensured the safe transmission and share of the data is the management unit of the network. Also it is the gateway between BAN and external networks (such as Zigbee, WiFi etc.). As the basic platform for obtaining, processing and transmission human physiological signals BAN can easily carry out long term and continuous detection and real time information feedback for human body physiological status. It enables the health care to be free from restrictions of time and space, prevents the happenings of dangerous symptoms, and improves life quality of people.

Since the concept of BAN was put forward, it has obtained

Permission to make digital or hard copies of all or part of this work for personal or classroom use is granted without fee provided that copies are not made or distributed for profit or commercial advantage and that copies bear this notice and the full citation on the first page. To copy otherwise, to republish, to post on servers or to redistribute to lists, requires prior specific permission and/or a fee.

BODYNETS 2011, November 07-08, Beijing, People's Republic of China

Copyright © 2012 ICST 978-1-936968-29-9

DOI 10.4108/icst.bodynets.2011.247165

attentions from the scholars of different industries. The relevant research focuses on the aspects of microminiaturization design, low consumption circuit design, network communication methods, biologic signal processing and so on for the sensors and actuator. Among them, how to realize reliable data communication between wearable and integrated sensors is one of the key technologies for BAN.

There are two ways to realize the communication between sensor nodes in BAN: one uses wireless channels around human bodies, the other one is to use human bodies as the channels for communication, called intra-body communication (IBC). Currently, most of the researches are focus on the first way. The researches on human body channel for BAN are relatively rare. The advantages of using human bodies for communication between nodes is the signals transmitted within human bodies [1] it only influenced by human body structure. The impacts of external environments are weak as well as the motions of the limbs won't change the topology structure of the networks. Therefore, it's relatively stable and suitable for multi-path environments. The realization of intra-body communications explores a wider field for BAN development.

The existing IBC methods can be divided into capacitive coupling type and galvanic coupling type [2, 3, 4], shown in FIG. 1(a). The principle of the first one is that, the signal terminal of the transmitter generates alternating electric field, the human bodies used as dielectric are dielectric polarized due to the electric field produced nearby, and generates weak coupling electric field; the signal terminal of the receiver is used to detect the variation of this electric field, and then the communication is realized. However, as the transmission loop is formed by coupling to earth on the terminal of transmit-receive unit, the communication quality is influenced by surrounding environments significantly, also it's impacted by the size of the effective coupling area on the other terminal of the transceiver unit.

In the galvanic coupling type IBC, the transmitting electrodes of the terminal attached on human skin injects safe alternating current into human body, and the detecting electrodes on the other terminal receives differential voltage signals to realize information transmission. Comparing with Capacitive coupling type, the process of realization for Galvanic coupling type IBC is free from the influences of grounding factor and surrounding environments, and has a better adaptability and stability.

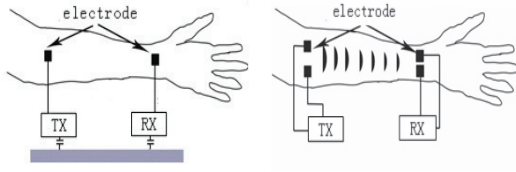

(a) Capacitive coupling type (b) Galvanic coupling type
Figure 1. The principle diagram of IBC

Basis on the quasi-static field electromagnetic modeling and body channel characteristic analysis [6,7,8], this paper design a transceiver for the galvanic coupling IBC to realize modulation and demodulation as well as sending and receiving current signal with the mode of 2CPFSK within the human body. This can successfully realize the data transmission in the circumstances of human-arms and many people hands touching, reflecting advantages of simplicity, stability and can be applied to information transmission in various sensor nodes of body area network.

SYSTEM DESIGN

The galvanic coupling IBC is consisted of transmitter and receiver illustrated in FIG.2. The transmitter is composed of master controller module, DDS module and current source module. ATmega8 is adopts as the transmitter's microcontroller. The base-band signal is modulated into phase-continuous simulated sine wave signal by the DDS chip AD9854. Through filtering harmonics and spurious emission interference by low pass filter and current source module, sinusoidal alternating current signal suitable for intra-body communication can be attained. Then it is injected to human body via the coupling electrodes.

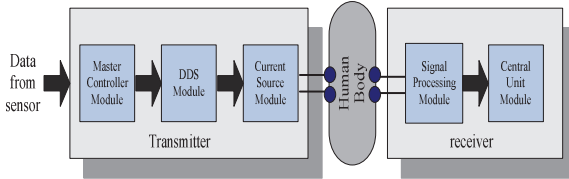

Figure 2. The basic diagram of the galvanic coupling IBC

IBC receiver is consisted of the signal processing module and central unit module. The detected electrodes receive potential signal differentially. Then signal processing module is used to amplify, filter, shape and level switch the signal received until digital signal suitable for inputting central module unit, which adopts Cyclone II EP2C35F672C6 chip as the control to collecting, demodulating, processing and storing signals. The following is the explanation of these key modules.

DDS Module

DDS (Direct Digital Synthesis) has the advantages such as high precision in output signal, rapid frequency conversion, continuous output signal, convenient control and high performance cost ratio, etc. This system has chosen AD9854 with rich IO port function, the internal functional block diagram is in FIG.3, this chip has built-in 48-Bit frequency accumulator, 48-Bit phase accumulator, sine and cosine waveform table, 12 phase orthogonal digital-analog converter and modulation and control circuit. Subject to controlling of clock signal, accumulator will accumulate the corresponding frequent characters of output signal frequency, and then plus phase character until the final phase information is

formed. Sine ROM sheet transform the phase information into amplitude information, then by means of DAC, sinusoidal signal is generated. At last, sine wave analog signals with pure frequency spectrum and continuous phase is obtained by the low pass filter.

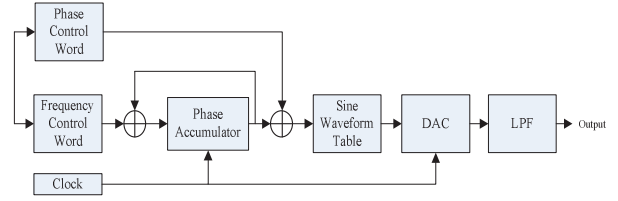

Figure 3. The function diagram of the AD9854

Carrier frequencies of 2CPFSK this paper designs are 50 kHz and 100 kHz respectively. The work clock is 50MHz. Frequency control word bit $n=48$. Frequency resolution Δf and output frequency f_{out} of DDS can be calculated through the following formula:

$$\Delta f = f_{clk} / 2^n$$

$$f_{out} = \Delta FC \times f_{clk} / 2^n, \quad 0 < \Delta FC < 2^n$$

Where, f_{clk} is the frequency of the work clock and ΔFC is the frequency control word.

There are two frequency word registers in AD9854: FREQ0 and FREQ1 whose values can be chosen through related bits of off-chip pin FSELECT or in-chip control register as the frequency word of output signal. By writing two corresponding values of different frequency to FREQ0 and FREQ1 respectively, output port can receive signal from 2CPFSK.

Current Source Module

This paper has utilized the current feedback amplifier AD844 to design the voltage-controlled current source based on the principle of current conveyor of the second generation, the sine wave voltage signal from DDS module is converted to current signal, shown in FIG.4. In order to avoid the error caused by low gain accuracy of first-step AD844, a broadband operational amplifier is applied as the input buffer, turning output resistance into zero and preventing the expected transconductance from errors. And then DC feedback circuit is designed for preventing the output blocking capacitor from saturation caused by DC signal.

The output current I_o is: $I_o = V_i / R$, regulating R produces output current 1mA, ensuring the safe current transmission in human body.

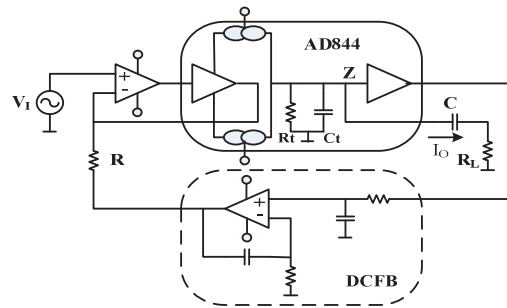

Figure 4. The circuit of the current source

Signal Processing Module and Central Unit Module

Diagrams of the signal processing module and central unit module's structure are shown in FIG.5. The receiving terminal amplifies the signal received by the difference amplifier and eliminates noise interference in the received signal by the BPF wave filter until necessary carrier signal is obtained. Then through clipping shaping, carrier signal becomes rectangular pulse, which is then modulated into pulse signal that can be directly inputted in central unit module with the aid of photoelectric isolation. In the end, demodulation signal is restored to the original sending signal by means of central unit module inside the central unit module.

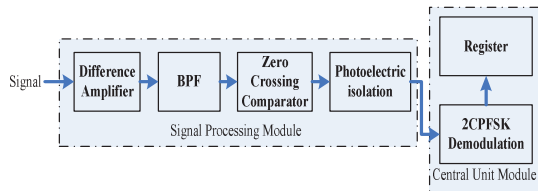

Figure 5. The structure of signal processing module and central unit module

EXPERIMENTATION

During the measurement, using a healthy male volunteer's upper arm as the communication medium, transmitter electrodes (40 mm × 40 mm in area) were used for coupling the signal into the human body and picked up the signal at the receiving electrodes. As shown in Fig. 6, two electrodes were attached 50mm away from the elbow as transmitter and the receiver was 80mm away from transmitter. The waveform of sending terminal and receiving terminal conduct is recorded by the oscilloscope Agilent MSO7054A (using the differential probe).

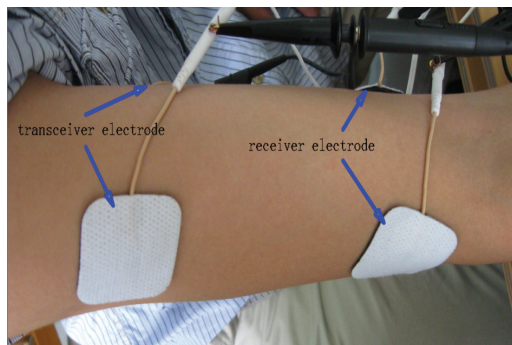

Figure 6. Measurement setup

A string of transmission rates of code element as cyclical sequence "0010111" with 5kbit/s is sent to directly through transmitter sequence control. Then modulating "0" or "1" as sine signals with carrier wave's upper and lower side frequency of 50 kHz and 100 kHz respectively. Next, by means of current source module, converting it into sine wave with threshold current suitable for human health as the sine alternating current signal inputted in human bodies (intra-body communication experiment adopts an effective value of less than 1mA as human safe current). Output waveform of IBC transmitter is in FIG.7.

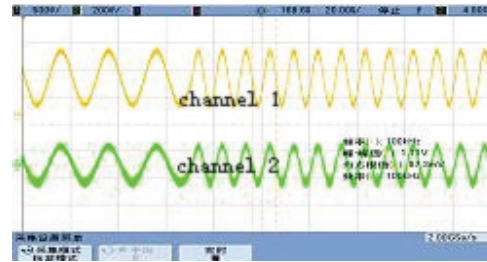

Figure 7. Output waveform of IBC transmitter

During the testing, current source module series connects a 100 Ω resistance, voltage waveform of the resistance is in channel 2 of FIG.7, it shown that the voltage of the resistance is 97.3mV, which indicates that the effective value of current output of current source module is 1mA as the design requires, thus human security can be ensured during the experiment.

Upon modulated current signal has being injected to human body, the receiving terminal adopts a pair of electrodes to receive voltage signal differentially. The signal received contains high-frequency harmonic wave and noise interference with sharp weakening of signal intensity. Finally, signal changes after going through the whole signal processing module and central unit module, as in FIG.8. Channel 1 of FIG.8 is the signal after amplifying wave filtering by signal processing module. Channel 2 is the result of clipping shaping. Channel 3 is the base band signal after restoring code element. Channel 4 bit sync signal. The lowest B1,B2 are the digital bus output ports of built-in embedded logic analyzer of oscilloscope Agilent MSO7054A. Transmitter circularly sends "00100111", and receiver gets corresponding signal, the results are shown in B1, B2. Code element indicates "00100111", identical to the digital base band signal sent, thus making the galvanic coupling IBC come true.

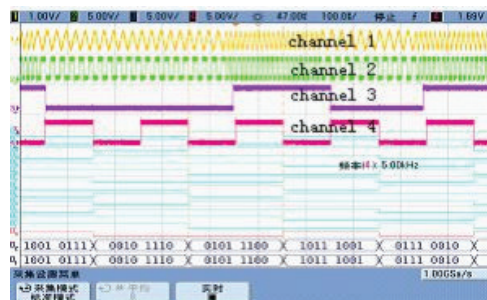

Figure 8. The waveform of IBC receiver

Based on the above experiment, this paper designs experiments of sending electrode and receiving electrode stick on different experimental subjects. Because ambient temperature and humidity can influence impedance characteristics in different parts of human body, and human organism such as muscle, skeleton, skin, fat, joint vary in fading characteristic of signals, thus signal transmission in different bodies is very difficult. The experiment schematic drawing for many people touching is shown in FIG. 9 (a), (b), the experimental results are shown in FIG.10 (a), (b). It is clear that when their hands don't touch, even very close to each other, received signal of the receiving terminal (channel 2) is caused by electromagnetic interference that produces a few scattered narrow pulse, failing to receive circular data "0010111" sent by the sending terminal; once their hands touch,

the receiving terminal can successfully receive circular data “0010111”.

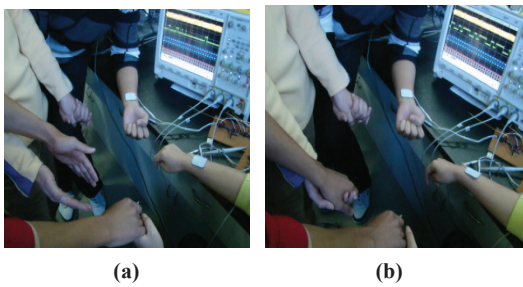
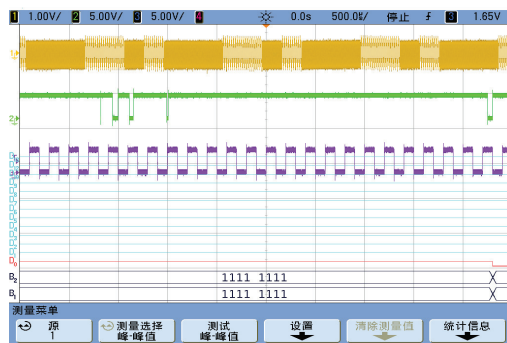
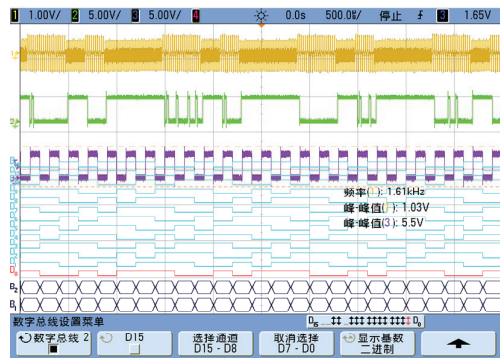

Figure 9. The experiment of two-hand touching



(a) The waveform when their hands don't touch



(b) The waveform when their hands touch

Figure 10. The experimental results of their hands touching

CONCLUSION

Based on the principle of the galvanic coupling IBC, this paper successfully designs a highly reliable and stable transceiver system. For the transmitter, DDS is used to modulate the original signal collected with the mode of 2CPFSK, and then with the aid of current source module, it is converted to alternating current signal suitable for human body transmission. For the receiver, the main work is designing the signal processing module and central unit module. The former is mainly used to amplification-filtering, clipping, shaping of the signal received; the latter is used to demodulate and store the signals. When the transmission rate of

the code element is 5kbit/s, the transceiver can successfully realize the data transmission in the circumstances of human-arms and many people hands touching which is the preliminary study on applying intra-body communication technology in body area network.

ACKNOWLEDGMENTS

The work presented in this paper is supported by the National Natural Science Foundation of China as 51047001, the Natural Science Foundation of Fujian Province as 2011J05077, the Funds of Fujian Provincial Department of Education as JK2010006 and the Science and Technology Development Fund of Macau under grant 014/2007/A1, 063/2009/A and 024/2009/A1, the Research Committee of the University of Macau under Grants UL012/09-Y1/EEE/VMI01/FST, RG077/09-10S/VMI/FST, RG075/07-08S/10T/VMI/FST, and RG072/09-10S/MPU/FST.

REFERENCES

- [1] T. G. Zimmerman. Personal Area Networks (PAN): Near-Field Intra-Body Communication. in Media Art and Science. vol. Master Thesis: Massachusetts Institute of Technology, 1995.
- [2] M.S. Wegmuller. Intra-body communication for biomedical sensors networks, in ETH Zurich. VOI. Phd Zurich: Swiss Federal Institute of Technology Zurich (ETH), 2007.
- [3] M. S. Wegmueller, A. Kuhn, J. Froehlich, et al. An Attempt to Model the Human Body as a Communication Channel. IEEE Transactions on Biomedical Engineering, 2007, 54(10): 1851-1857.
- [4] K. Hachisuka, A. Nakata, T. Takeda, et al. Development of wearable intra-body communication devices. Sensors and Actuators A physical, 2003, 109-115.
- [5] M. Wegmueller, A. Lehner, J. Froehlich, et al. Measurement System for the Characterization of the Human Body as a Communication Channel at Low Frequency, in 27th Annual International Conference of the Engineering in Medicine and Biology Society, 2005 (IEEE-EMBS 2005), 2005. 3502-3505.
- [6] Y. M. Gao, S. H. Pun, M. Du, M. I. Vai, and P. U. Mak. A preliminary two dimensional model for Intra-body Communication of Body Sensor Networks, in International Conference on Intelligent Sensors, Sensor Networks and Information Processing (ISSNIP 2008), Sydney, 2008, pp. 273-278.
- [7] Y. M. Gao, S. H. Pun, P. U. Mak, M. Du, and M. I. Vai, Preliminary modeling for intra-body communication, in 13th International Conference on Biomedical Engineering (ICBME2008), Singapore, 2008, pp. 1044-1048.
- [8] Gao Yue-ming, Pun Shao-heng, Du Min, et al. A multilayer cylindrical volume conductor model for galvanic coupling intra-body communication, in the 7th International Conference on Information, Communications and Signal Processing (ICICS 2009), Macau, 2009, pp.1-4.