

A Dynamic-Range-Improved 2.4GHz WLAN Class-E PA Combining PWPM and Cascode Modulation

Yinsidi Jiao, Wei-Han Yu, Pui-In Mak and Rui P. Martins¹

The State Key Laboratory of Analog and Mixed-Signal VLSI, University of Macau, Macao, China

¹ – On leave from Instituto Superior Técnico (IST)/TU of Lisbon, Portugal

Abstract—A dynamic-range-improved class-E power amplifier (PA) is achieved via combining cascode modulation and pulse-width pulse-position modulation (PWPM). PWPM can avoid the need of supply modulator yielding better power efficiency than the classical techniques. The key pitfall of PWPM is the fact that a high-frequency narrow pulse can be swallowed by the pulse driver, showing zero output when the signal is of a small amplitude. Such a problem is solved by combining PWPM with the cascode modulation. The PWPM is to serve the master mode when the pulse width is sufficiently wide. When the pulse width is adequately narrow, the PA switches to the slave mode, which utilizes an analog control voltage to drive up the cascode device. Such a combined structure results in a high dynamic range. A 2.4GHz WLAN class-E PA is designed in 65nm CMOS to verify the structure. Together with a digital predistortion scheme for AM-AM and AM-PM compensation, the PA exhibits an EVM of 0.55% with an average output power of 21dBm under an OFDM 64-QAM input. The average power-added efficiency is 27%.

I. INTRODUCTION

With the advent of CMOS sub-micron technologies it has been feasible to develop low-power portable devices with high level of integration and low production costs. RF power amplifier (PA), as one of the most power-hungry transmitter blocks, dominates almost the overall power budget of the transceiver. Power efficiency and linearity are the two crucial performance metrics of a PA. The class-E PA uses a switch and an output matching network to achieve a high efficiency by zero voltage switching [1], [2]. A class-E PA with pulse width and pulse position modulation (PWPM) [3] can achieve linearization without entailing a supply modulator, yielding better power efficiency. However, the relationship between the pulse width and output voltage is inherently nonlinear, which can cause nonlinear correlation between the input amplitude and output voltages, limiting its application for only constant envelop modulation. This paper describes a cascode-modulated PWPM PA enlarging the dynamic range power efficiently. The linearity is furthered via digital predistortion such that the overall performance can meet the IEEE 802.11b/g WLAN standard.

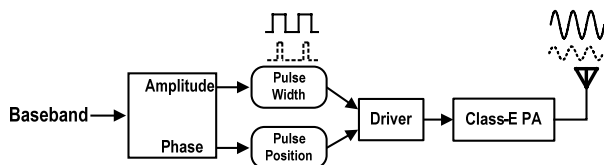

Fig. 1. Typical PWPM class-E PA [3]

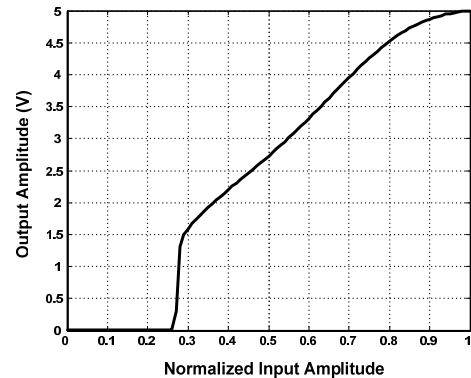

Fig. 2. Typical AM-AM characteristic of a PWPM class-E PA.

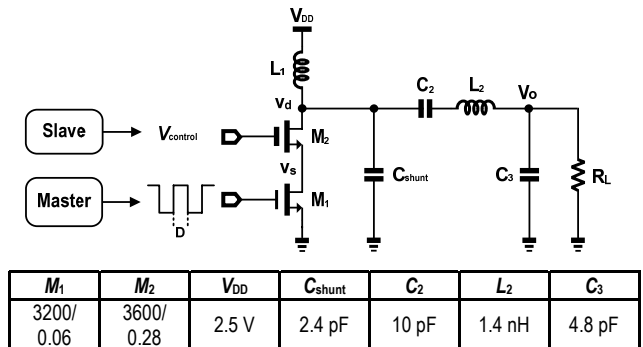

Fig. 3. Proposed PWPM class-E PA with added cascode modulation

II. PWPM CLASS-E PA

The class-E PA achieves a high power-added efficiency (PAE) via zero-voltage switching. A number of techniques such as impedance transformation, device stacking and differential configuration have been employed to boost up the maximum output power. For linearization, PWPM is a power-efficient alternative because it does not necessitate a supply modulator that is power hungry. The concept of PWPM Class-E PA is illustrated in Fig. 1. At the baseband, quantity of amplitude is converted to the pulse width proportionally. Large (small) pulse width would cause large (small) output amplitude, but the relation is inherently nonlinear. Fig. 2 shows the AM-AM characteristic curve when baseband amplitude is swept: a small pulse width happening with small input amplitudes is swallowed by the driver (i.e. taped inverter chain) due to its finite response time, resulting in zero output voltage. This is the main issue that limits the conventional PWPM for modern wireless communication standards (i.e. OFDM).

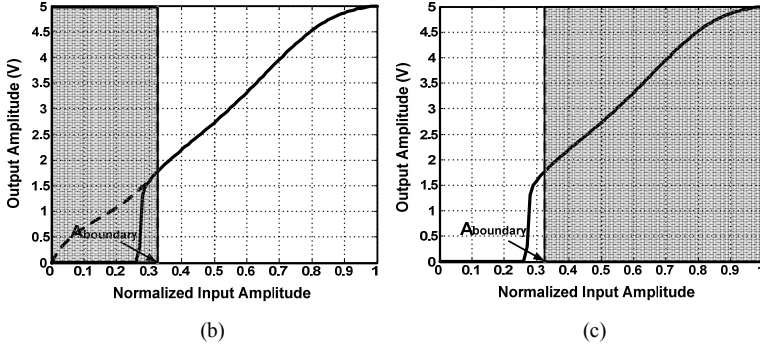
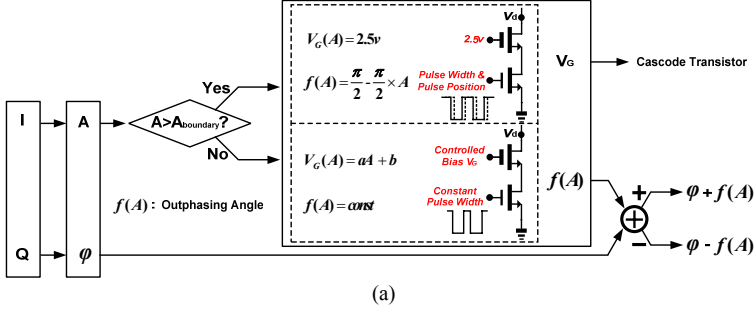

Fig. 4. Control mechanism: (a) The principle. (b) I/O characteristic in slave mode. (c) I/O characteristic in master mode.

III. CASCODE-MODULATED PWPM CLASS-E PA

To address such an issue raised by a small pulse width, this paper proposes a cascode-modulated PWPM class-E PA (with differential implementation) as shown in Fig. 3. Instead of biasing the cascode transistor (M_2) with V_{DD} , the gate voltage can now be modulated with $V_{control}$ [4].

There are dual operating modes. The principle of the dual-mode control mechanism and their I/O characteristics in the slave and master modes are illustrated in Fig. 4(a). The pure PWPM is for the master mode, whereas the analog control of M_2 's gate voltage is for the slave mode. The improved AM-AM characteristic is shown in Fig. 4(b) and (c). $V_{control}$ can be generated via an analog amplifier.

The detailed operation mechanism is described as follows: the aim is to compensate the fact that a small pulse width can be swallowed by the pulse driver. First, the boundary value of the input amplitude is determined by the AM-AM curve. When the input amplitude is large (i.e. $A > A_{boundary}$), PA adopts the original linearization method of PWPM (master mode). However, when the input amplitude is small enough, the output amplitude is controlled by $V_{control}$, which extends the dynamic range of the PA (slave mode). Intuitively, the lower the bias voltage of M_2 , the smaller the output voltage becomes since the ON-resistance of M_2 grows bigger. As a result, the power consumption is increased as the tradeoff. Nevertheless, M_2 is only entailed in the slave mode. The linearization is simply assumed to be a linear equation, i.e.,

$$V_G = aA + b \quad (1)$$

where,

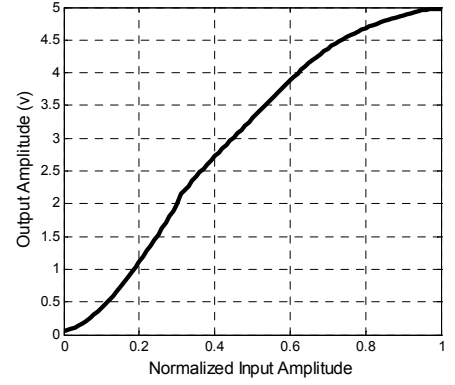

Fig. 5. AM-AM characteristics of the proposed PA.

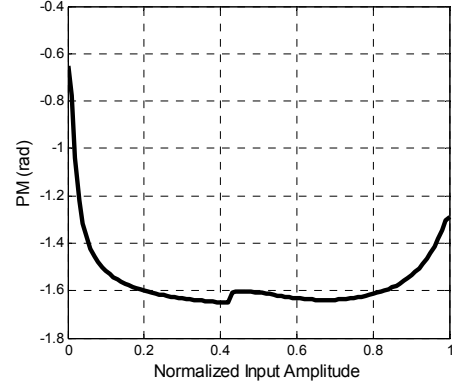

Fig. 6. AM-PM characteristics of the proposed PA.

$$A \in [0, A_{boundary}]$$

$$V_G \in [b, a \times A_{boundary} + b]$$

Besides, the pulse width in this mode is entailed to be constant which implies that,

$$f(A) = const \quad (2)$$

The duty cycle after PWPM combination becomes,

$$D = \frac{\pi - 2const}{2\pi} \times 100\% \quad (3)$$

In order to extend the dynamic range and then apply digital predistortion on the AM-AM curve, the parameters (a , b and $const$) should be determined. In the slave mode, the minimum pulse width should be used so that,

$$const = \frac{\pi - 2\pi D_{min}}{2} \quad (4)$$

The minimum gate voltage b should be minimized to ensure linearity and it can be set to the threshold voltage V_{TH} . In the integrated 65nm CMOS process employed, $b = 0.5$ V can be used. The parameter a is tuned such that the maximum output amplitude could be equal to the boundary amplitude $A_{boundary_out}$ to ensure the continuity.

The synchronization between pulse width and the gate control voltage is of concern since the driver can cause some

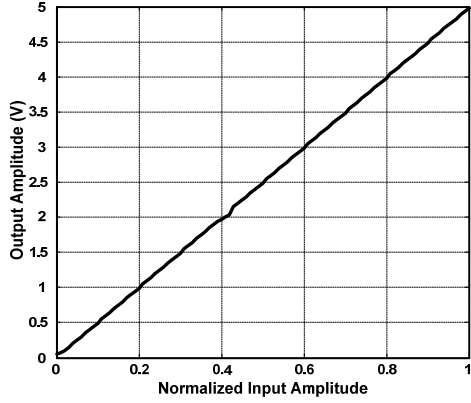

Fig. 7. AM-AM of the proposed cascode modulated class-E PA after digital predistortion.

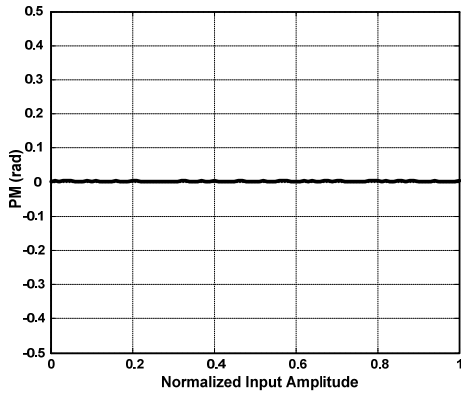

Fig. 8. AM-PM of the proposed cascode modulated class-E PA after digital predistortion.

delay. With the two control modes in the proposed class-E PA, the AM-AM characteristics are plotted in Fig. 5, whereas the simulated AM-PM characteristics is plotted in Fig. 6. It can be observed that the dynamic range is increased to the whole input range (0 ~ 1).

IV. DIGITAL PREDISTORTION (DPD)

In order to meet the linearity requirements of WLAN, digital predistortion is also utilized to improve the linearity. The predistortion is accomplished by a 100-point Look-Up Table (LUT) with interpolation. The AM-AM and AM-PM curves after digital predistortion are shown in Figs. 7 and 8, respectively. The nonlinearity at $A = 0.4$ is due to the switch between the two modes and it would be improved if more points are utilized in LUT.

V. SIMULATION RESULTS

In practical applications S_{22} is a crucial factor that has to be taken into consideration. As for a generic switching PA, the output resistance R_o can vary according to the pulse width. For the proposed PA, S_{22} versus baseband amplitude under different frequencies is simulated as shown in Fig. 9.

S_{22} under the operating frequency roughly passes the specifications except when the baseband amplitude is ~ 0.5 .

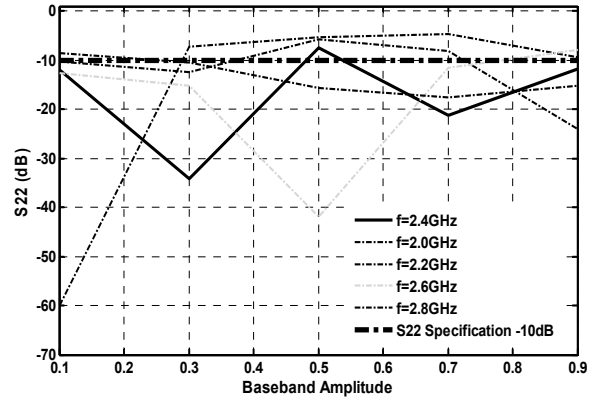

Fig. 9. S_{22} versus baseband amplitude (duty cycle).

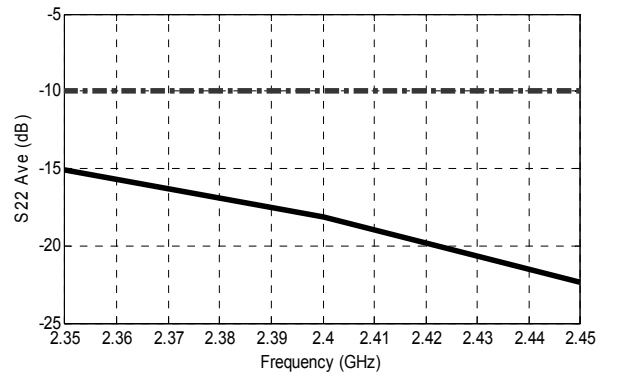

Fig. 10. Average S_{22} under OFDM 64QAM with different carrier frequencies is compliant with the general specification of -10dB (the dotted line).

Furthermore, it is worth to investigate the average S_{22} under a specific modulation. For instance, the pulse width of OFDM 64QAM is extracted and then applied to the PA. Under different carrier frequencies (variations due to LO), the average S_{22} is plotted as shown in Fig. 10. It can be observed that the average S_{22} under an OFDM 64-QAM signal passes the general specification of -10dB .

The linearity of the PA is tested by the OFDM signals of the 802.11b/g standard and one OFDM signal consists of 52 subcarriers modulated by 64-QAM. Then, it is passed to a raised-cosine filter up sampled by 10 times, which pulls the image apart from the signal band further. In the simulation model, the transmitted signal is received by an ideal receiver to down-convert the signal back to the baseband for linearization. Synchronization has to be performed since the system can cause some delay. Hence, synchronization aims to find delay samples at which the minimum mean square error between input and output amplitudes occurs, i.e.,

$$Error = \sum \sqrt{(I_{out}(i) - I_{in})^2 + (Q_{out}(i) - Q_{in})^2} \quad (5)$$

At the received baseband, the time delay i is swept such that the least mean error is minimized. With this time delay, the input and output amplitudes are plotted together in Fig. 11, which indicates the nearly perfect matching.

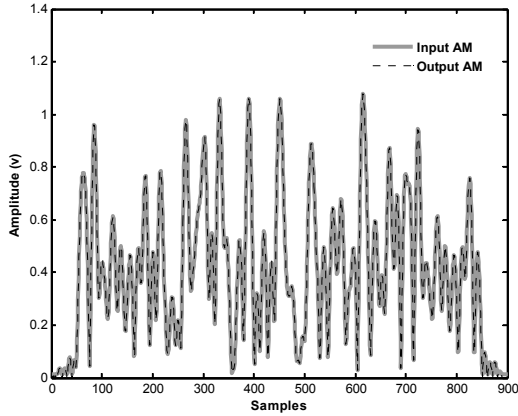

Fig. 11. Input and output amplitudes showing the matching.

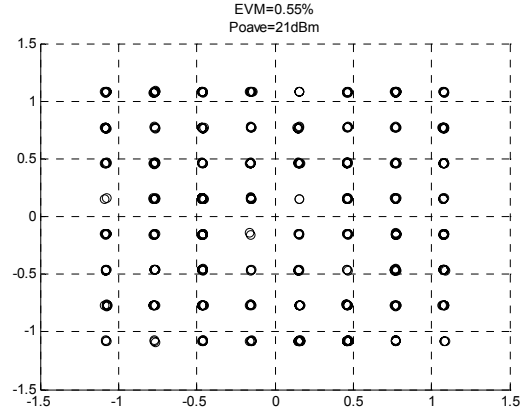
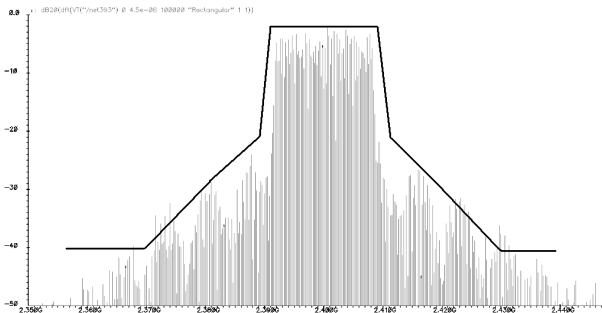
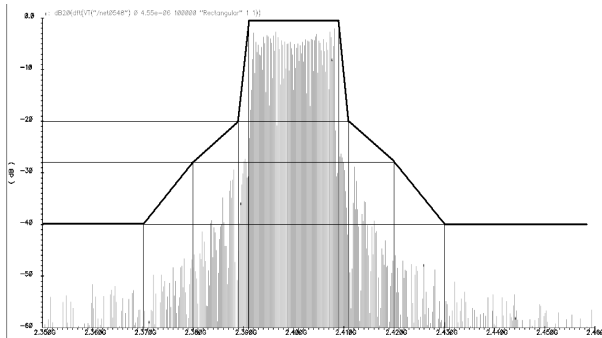

Fig. 13. Constellation diagram of an OFDM 64-QAM signal.



(a)



(b)

Fig. 12. RF spectrum at 2.4 GHz: (a) with AM-AM compensation only. (b) with both AM-AM and AM-PM compensation.

Fig. 12 shows the spectrum at the RF output with AM-AM predistortion only and AM-AM, AM-PM predistortion. In the latter case, the class-E PA achieves 27% average PAE and 21dBm average output power under 64QAM OFDM with 0.55% EVM (Fig. 13). Furthermore, according to the 802.11b/g standard, EVM is required to be smaller than 5% only. Therefore, the power back-off can be reduced so that the average output power can be even larger.

VI. CONCLUSIONS

A novel class-E PA combining PWPM and cascode-modulation has been proposed. The PWPM is for the master

TABLE I:
BENCHMARK WITH PRIOR ARTS.

	This work (Simulation)	[3] (Measurement)
Technology	65nm	65nm
P_{out peak}(dBm)	30.5	28.6
Peak Efficiency (%)	58	28.5
Linearization	PWPM + Cascode Modulation + DPD	PWPM
EVM (%)	0.55	4.6
Avg. P_{out} (dBm)	21	26.7 *
Avg. PAE (%)	27	21

* Constant envelope has higher average P_{out}.

mode when the pulse width is sufficiently wide. When the pulse width is small enough, the PA is switched to the slave mode, which utilizes an analog control voltage to modulate the cascode device. This technique enlarges the dynamic range since the pure PWPM with a small pulse width can be swallowed by the pulse driver. Optimized in 65nm CMOS, a 2.4GHz WLAN cascode-modulated class-E PA with DPD shows 0.55% EVM, 21dBm average output power and 27% average PAE. A summary of simulated performances is given in Table I. The results of [3] are added for reference only as it is based on measurements.

Acknowledgement - This work was supported by RC of University of Macau and Macao FDCT.

REFERENCES

- [1] N. Sokal, A. Sokal, "Class E, A New Class of High Efficiency Tuned Switching PAs" *IEEE J. Solid-State Circuits*, vol.10, no. 3, pp 168-176, Jun. 1975.
- [2] F. H. Raab, "Idealized Operation of the Class E Tuned Power Amplifier," *IEEE Trans. Circuits Syst.*, vol. 24, pp. 725-735, Dec. 1977.
- [3] J. S. Walling, H. Lakdawala, Y. Palaskas, A. Ravi, O. Degani, K. Soumyanath, and D. J. Allstot, "A 28.6 dBm 65 nm class-E PA with Envelope Restoration by Pulse-width and Pulse-Position Modulation," in *IEEE ISSCC Dig. Tech. Papers*, pp. 566-567, Feb. 2008.
- [4] A. Mazzanti, L. Larcher, R. Brama and F. Svelto, "Analysis of Reliability and Power Efficiency in Cascode Class-E PAs," *IEEE J. Solid-State Circuits*, vol. 41, no. 5, pp. 1222-1229, May 2006.