

An Adaptive Source Current THD Oriented Fuzzy Logic Controller in Hybrid Power Filter

Wai-Hei Choi, Chi-Seng Lam, Man-Chung Wong
Department of Electrical and Electronics Engineering
University of Macau
Macau, SAR, P. R. China
ma96556@umac.mo

Abstract—This paper presents an adaptive source current THD oriented fuzzy logic controller for a 3-phase 4-wire center split hybrid power filter. The controller adaptively changes the hysteresis band in order to trace the reference total harmonic distortion – THD of the source current at the desired value, so that the switching frequency and switching losses can be minimized, thus reduces the total costs of the system. The proposed control method is workable in PI and fuzzy logic control and is verified by simulations. Moreover, the comparison between the PI and fuzzy logic control is also studied.

I. INTRODUCTION

The more use of power electronic equipments and non-linear devices in power systems has given rise to power quality problems, mainly in reactive power and current harmonic. High current harmonic causes various problems in power systems and in consumer products, such as equipment overheating, blown capacitor fuses, transformer overheating, excessive neutral current, low power factor, etc [1][2].

In order to diminish the current THD, shunt passive, active and hybrid power filters can be implemented. Passive power filters (PPF) have disadvantages about fixed compensation and resonance problems, while active power filters (APF) are considered high rating with higher cost. Hybrid power filters (HPF) topologies composed of PPF connected in series to APF, which significantly improve the compensation characteristics of PPF, also make the APF available for high power applications, at a relative lower cost.

Among various control methods for compensating the harmonic current, hysteresis band (HB) current control method is the most popularly used because of the simplicity of implementation and fast controllability. In principle of decreasing HB leads increasing inverter operation frequency and helps to get a better compensating waveform with low THD. Normally, HB should be smaller in order to get a better performance with small THD. Moreover, less HB means higher switching frequency of the switching devices,

as a result, higher switching losses is one of disadvantages. Therefore, a new control strategy is proposed to adaptively changing the HB according to the desired source current THD value, so that the switching frequency and switching losses can be minimized, thus reduces the total costs of the system. Furthermore, since it is not easy to find out the direct relationship between source current THD and HB, the fuzzy logic controller is suitable to apply in here. Hence, a novel adaptive source current THD oriented fuzzy logic controller is proposed in this paper, in order to adaptively changing the HB for optimizing the switching frequency and the source current THD. Finally, simulation results are presented to verify the proposed control method, and a comparison between the proportional-integral (PI) and fuzzy logic control is also given.

II. HPF STRUCTURE AND MATHEMATICAL MODEL

A HPF is composed of a PPF and an APF, which combines both advantages of two filters for providing a cost-effective solution for power quality compensation of the nonlinear load [3].

Due to the development of the ‘custom power’ concept, the 3-phase 4-wire system will play a very important role in the distribution site. There are two common topologies to provide neutral current compensation in the 3-phase 4-wire system via 3-phase voltage-source inverter: (a)3-leg center split topology; (b)4-leg topology. For the economical consideration, the 3-leg center split topology can reduce the initial costs because of less switching devices are required, therefore, it is more preferable and is chosen in this paper. However, its DC-link control strategy is relatively complicated as compared with the 4-leg one [4]. In this paper, since the main idea is the proposed adaptive source current THD oriented fuzzy logic controller, the DC-link voltage control will not be discussed and all the following analysis will be based on sufficient and stable DC-link voltage condition.

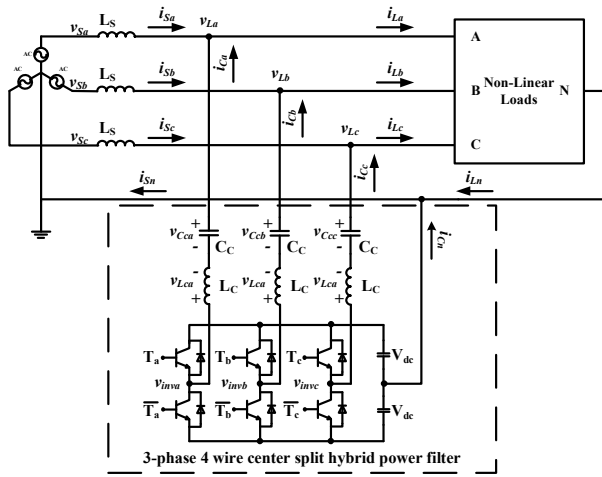

Figure 1. Circuit structure of hybrid power filter.

The circuit structure of a HPF is shown in Fig. 1. v_{Sx} ($x=a,b,c$) is the source voltage, v_{Lx} is the load voltage, L_S is the system inductance normally neglected due to its low value compared to load value, thus $v_{Sx}=v_{Lx}$; i_{Sx} and i_{Lx} are the source and load current, i_{Cx} is the compensating current; T_x and \bar{T}_x are the complementary trigger signals; C_C and L_C are the coupling part capacitance, and inductance.

The switching function of the inverter can be expressed as (1),

$$s_x = \begin{cases} 1 & \text{when } T_x \text{ closed, } \bar{T}_x \text{ opened} \\ -1 & \text{when } T_x \text{ opened, } \bar{T}_x \text{ closed} \end{cases} \quad (1)$$

The DC link voltage is assumed to be an ideal voltage source, the terminal inverter voltage v_{inva} , v_{invb} , v_{invc} can be expressed as (2),

$$\begin{bmatrix} v_{inva} \\ v_{invb} \\ v_{invc} \end{bmatrix} = V_{dc} \begin{bmatrix} s_a \\ s_b \\ s_c \end{bmatrix} \quad (2)$$

Moreover, since the system voltage is balanced, the neutral voltage, neutral compensating current and neutral capacitor voltage can be defined as (3), (4) and (5) respectively,

$$v_{Sn} = \frac{1}{3}(v_{Sa} + v_{Sb} + v_{Sc}) = 0 \quad (3)$$

$$i_{Cn} = \frac{1}{3}(i_{Ca} + i_{Cb} + i_{Cc}) \quad (4)$$

$$v_{Ccn} = \frac{1}{3}(v_{Cca} + v_{Ccb} + v_{Ccc}) \quad (5)$$

According to (3), (4), (5) and Fig. 1, the relation among the compensating currents (i_{Ca} , i_{Cb} , i_{Cc} , i_{Cn}), the source voltages (v_{Sa} , v_{Sb} , v_{Sc}), the capacitor voltages (v_{Cca} , v_{Ccb} , v_{Ccc} ,

v_{Ccn}) and the inverter voltages (v_{inva} , v_{invb} , v_{invc}) can be expressed as,

$$\begin{cases} L_C \frac{di_{Ca}}{dt} = v_{inva} - v_{Sa} + v_{Cca} \\ L_C \frac{di_{Cb}}{dt} = v_{invb} - v_{Sb} + v_{Ccb} \\ L_C \frac{di_{Cc}}{dt} = v_{invc} - v_{Sc} + v_{Ccc} \\ L_C \frac{di_{Cn}}{dt} = v_{inva} + v_{invb} + v_{invc} + v_{Cca} + v_{Ccb} + v_{Ccc} \end{cases} \quad (6)$$

$$\begin{cases} C_C \frac{dv_{Cca}}{dt} = -i_{Ca} \\ C_C \frac{dv_{Ccb}}{dt} = -i_{Cb} \\ C_C \frac{dv_{Ccc}}{dt} = -i_{Cc} \\ C_C \frac{dv_{Ccn}}{dt} = -i_{Cn} \end{cases} \quad (7)$$

From (6) and (7), a general mathematical model of the 3-phase 4-wire 3-leg center split HPF in a-b-c-n frame can be established as

$$\dot{\mathbf{Z}}\mathbf{X} = \mathbf{A}\mathbf{X} + \mathbf{B}\mathbf{U} \quad (8)$$

where

$$\mathbf{Z} = \text{diag}[L_C \quad L_C \quad L_C \quad L_C \quad C_C \quad C_C \quad C_C \quad C_C]$$

$$\mathbf{X} = [i_{Ca} \quad i_{Cb} \quad i_{Cc} \quad i_{Cn} \quad v_{Cca} \quad v_{Ccb} \quad v_{Ccc} \quad v_{Ccn}]^T$$

$$\mathbf{A} = \begin{bmatrix} 0 & 0 & 0 & 0 & 1 & 0 & 0 & 0 \\ 0 & 0 & 0 & 0 & 0 & 1 & 0 & 0 \\ 0 & 0 & 0 & 0 & 0 & 0 & 1 & 0 \\ 0 & 0 & 0 & 0 & 0 & 0 & 0 & 1 \\ -1 & 0 & 0 & 0 & 0 & 0 & 0 & 0 \\ 0 & -1 & 0 & 0 & 0 & 0 & 0 & 0 \\ 0 & 0 & -1 & 0 & 0 & 0 & 0 & 0 \\ 0 & 0 & 0 & -1 & 0 & 0 & 0 & 0 \end{bmatrix}$$

$$\mathbf{B} = \text{diag}[1 \quad 1 \quad 1 \quad 1 \quad 1 \quad 1 \quad 1 \quad 1]$$

$$\mathbf{U} = \begin{bmatrix} V_{dc}s_a - v_{Sa} \\ V_{dc}s_b - v_{Sb} \\ V_{dc}s_c - v_{Sc} \\ V_{dc} \frac{s_a + s_b + s_c}{3} \\ 0 \\ 0 \\ 0 \\ 0 \end{bmatrix}$$

III. HPF COMPENSATION PRINCIPLE

According to the circuit structure of the HPF, it allows the APF to improve the compensation characteristic of the PPF with small rating under inductive non-linear load consideration.

The compensation principle of the shunt HPF is to generate a compensating current to the utility, so that it cancels harmonic current and corrects the power factor close to unity. The compensating current is achieved by the well-known instantaneous active and reactive power theory (p-q theory) proposed by H. Akagi [5]. By injecting the ideal compensating current into the system, the source current keeps pure sinusoidal and in phase with the source voltage.

The original p-q theory is based on instantaneous values in 3-phase power systems without neutral wire, and is valid for steady-state or dynamic operations. The core of p-q theory is to convert the instantaneous currents and voltage into instantaneous space vectors. 3-phase instantaneous voltages and currents on the a-b-c coordinates can be transformed into those on the 0- α - β coordinates by the Clarke transformation:

$$\begin{bmatrix} v_0 \\ v_\alpha \\ v_\beta \end{bmatrix} = \sqrt{\frac{2}{3}} \begin{bmatrix} 1/\sqrt{2} & 1/\sqrt{2} & 1/\sqrt{2} \\ 1 & -1/\sqrt{2} & -1/\sqrt{2} \\ 0 & \sqrt{3}/2 & -\sqrt{3}/2 \end{bmatrix} \begin{bmatrix} v_{Sa} \\ v_{Sb} \\ v_{Sc} \end{bmatrix} \quad (9)$$

$$\begin{bmatrix} i_0 \\ i_\alpha \\ i_\beta \end{bmatrix} = \sqrt{\frac{2}{3}} \begin{bmatrix} 1/\sqrt{2} & 1/\sqrt{2} & 1/\sqrt{2} \\ 1 & -1/\sqrt{2} & -1/\sqrt{2} \\ 0 & \sqrt{3}/2 & -\sqrt{3}/2 \end{bmatrix} \begin{bmatrix} i_{La} \\ i_{Lb} \\ i_{Lc} \end{bmatrix} \quad (10)$$

For a 3-phase 4-wire system, the modified p-q theory in [6] defines an instantaneous real power p and three instantaneous imaginary powers, q_0 , q_α and q_β as follows:

$$\begin{bmatrix} p \\ q_0 \\ q_\alpha \\ q_\beta \end{bmatrix} = \begin{bmatrix} v_0 & v_\alpha & v_\beta \\ 0 & -v_\beta & v_\alpha \\ v_\beta & 0 & -v_0 \\ -v_\alpha & v_0 & 0 \end{bmatrix} \begin{bmatrix} i_0 \\ i_\alpha \\ i_\beta \end{bmatrix} \quad (11)$$

The inverse transformation of the above equation is performed as follows:

$$\begin{bmatrix} i_0 \\ i_\alpha \\ i_\beta \end{bmatrix} = \frac{1}{v_0^2 + v_\alpha^2 + v_\beta^2} \begin{bmatrix} v_0 & 0 & v_\beta & -v_\alpha \\ v_\alpha & -v_\beta & 0 & v_0 \\ v_\beta & v_\alpha & -v_0 & 0 \end{bmatrix} \begin{bmatrix} p \\ q_0 \\ q_\alpha \\ q_\beta \end{bmatrix} \quad (12)$$

and

$$\begin{bmatrix} p \\ q \end{bmatrix} = \begin{bmatrix} p_0 + p_\alpha + p_\beta \\ q_0 + q_\alpha + q_\beta \end{bmatrix} = \begin{bmatrix} \bar{p} + \tilde{p} \\ \bar{q} + \tilde{q} \end{bmatrix} \quad (13)$$

where \bar{p} and \bar{q} are the instantaneous active and reactive power originating from the symmetrical fundamental component (positive-sequence) of the load current, \tilde{p} and \tilde{q} are the instantaneous active and reactive power originating from harmonic and the asymmetrical fundamental component (negative-sequence) of the load current.

In order to extract the compensated harmonic current, the reference harmonic current corresponding to reactive power on α - β -0 coordinates should be first calculated as follows:

$$\begin{bmatrix} i_{C0}^* \\ i_{C\alpha}^* \\ i_{C\beta}^* \end{bmatrix} = \frac{1}{v_0^2 + v_\alpha^2 + v_\beta^2} \begin{bmatrix} v_0 & 0 & v_\beta & -v_\alpha \\ v_\alpha & -v_\beta & 0 & v_0 \\ v_\beta & v_\alpha & -v_0 & 0 \end{bmatrix} \begin{bmatrix} \tilde{p} \\ q_0 \\ q_\alpha \\ q_\beta \end{bmatrix} \quad (14)$$

Finally, the compensated harmonic currents in a-b-c coordinates can be obtained by inversed matrix of Clarke transformation in α - β -0 coordinates:

$$\begin{bmatrix} i_{Ca}^* \\ i_{Cb}^* \\ i_{Cc}^* \end{bmatrix} = \sqrt{\frac{2}{3}} \begin{bmatrix} 1/\sqrt{2} & 1 & 0 \\ 1/\sqrt{2} & -1/2 & \sqrt{3}/2 \\ 1/\sqrt{2} & -1/2 & -\sqrt{3}/2 \end{bmatrix} \begin{bmatrix} i_{C0}^* \\ i_{C\alpha}^* \\ i_{C\beta}^* \end{bmatrix} \quad (15)$$

IV. SOURCE CURRENT THD ORIENTED WITH FUZZY LOGIC CONTROL

According to the power quality standards IEEE-519 [7], the source current THD should be limit within an acceptable range. A narrow HB can provide a good compensating performance with low current THD, and a high current THD will be occurred when the inverter of HPF is operating in a wide HB [8].

The switching loss of the switching device can be classified as turn-on and turn-off losses. (12) is the total turn-on and turn-off power loss given in [9]. In (12), V_{CC} , I_{CM} , I_{CN} , t_{rN} , and f are the DC-link voltage, maximum collector current, rated collector current, rated rise time, reated fall time and switching frequency respectively. It can be seen that except for the switching frequency, the other values are constant or determined by the characteristic of the switching devices. Therefore, it is obvious that the switching loss is directly proportional to the switching frequency[10].

$$P_{loss} = V_{dc} I_{CM} f \left(\frac{1}{8} t_{rN} \frac{I_{CM}^2}{I_{CN}} + t_{fN} \left(\frac{1}{3\pi} + \frac{1}{24} \frac{I_{CM}}{I_{CN}} \right) \right) \quad (12)$$

Therefore, a controller can be applied for controlling the HB value at a maximum level to minimize the switching frequency when the source current THD is at the acceptable value. The input and output variables of controller can be set as the error of source current THD and the change of HB respectively. Fig. 2 shows the single-phase control block diagram of the source current THD oriented control, it can be expanded into three-phase system. i_{Cx}^* is the reference compensating current, which is deduced by the p-q theory;

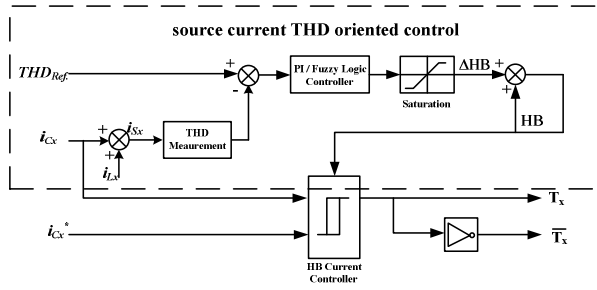

Figure 2. Single-phase control block diagram of source current THD oriented fuzzy logic controller.

i_{Cx} is the actual compensating current obtained by the difference of i_{Sx} and i_{Lx} . According to the control block diagram, the source current THD is firstly calculated and compared with a reference value THD_{ref} , a larger current THD value than the reference value means that the HB of inverter is not small enough; inversely, the HB needs to be increased when getting a smaller current THD value than the reference value. Then the HB signal will be sent to the HB current controller to generate the trigger signals, T_x and \bar{T}_x , this control loop will be continuously executed until an optimal HB is computed. Finally, the switches of the inverter are controlled to produce the compensating currents, which let the source current THD as the reference value. Under this control, the initial and operating cost of HPF can be further decreased by releasing the switching frequency. It is because the higher of the operating switching frequency, the more expensive and more stress of the switching devices.

However, the relationship between the source current THD and the HB is nonlinear and cannot be found easily, a fuzzy logic controller can be effectively applied to deal with in this kind of problem. The control action of a fuzzy logic controller is determined from the evaluation of a set of simple linguistic rules, these linguistic rules can be converted from the numerical variables of the real system, the following seven fuzzy levels or sets are chosen as [11]: NL (negative large), NM (negative medium), NS (negative small), Z (zero), PS (positive small), PM (positive medium), and PL (positive large). And the corresponding control rule can be established as Table I based on the intuitive feeling for, and experience of the process.

The fuzzy controller is characterized as follows: [12]

- 1 seven fuzzy sets for input and output;
- 2 triangular membership functions for simplicity;
- 3 fuzzification using continuous universe of discourse;
- 4 implication using Mamdani's minimum operator;
- 5 defuzzification using the center of gravity method.

TABLE I. FUZZY RULES OF FUZZY LOGIC CONTROLLER

errorTHD	NL	NM	NS	Z	PS	PM	PL
ΔHB	NL	NM	NS	Z	PS	PM	PL

V. SIMULATION RESULTS

In order to verify the performance of proposed control strategy, a simulation model is built by MATLAB/Simulink. Table II lists the simulated system parameters, and the DC-link voltage of the inverter is supplied by an ideal DC voltage source.

By using the proposed control method, the HPF has ability to compensate the source current at the required THD value. The source and neutral current compensation waveforms with $THD_{ref}=8\%$ are illustrated in Fig. 3. At 0.1s, the HPF is switched on to do the compensation with initial $HB=0.1$, the source current THD is under the reference value ($THD<8\%$) and trends to the reference value during 0.1s - 0.2s. After 0.2 s, the source current THD is controlled as the reference value ($THD=8\%$).

TABLE II. SYSTEM PARAMETERS IN THE SIMULATION

System parameters		Physical values
Source	$V_{x,rms}$	220Vac
	L_S	0.5mH
HPF	L_C	10mH
	C_C	40uF
	V_{dc}	80Vdc
Load	R_L	60 Ω
	L_L	30mH
	C_L	400uF

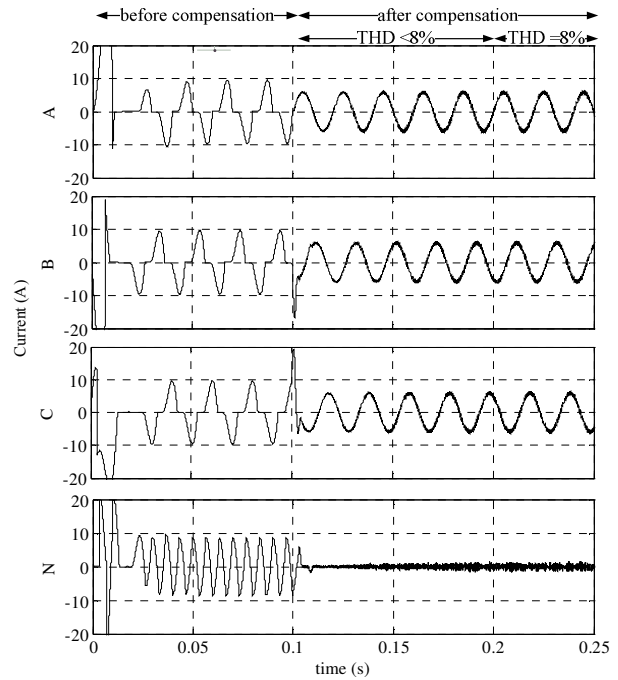

Figure 3. Source current compensation by using Current THD, HB and switching frequency waveforms with reference value $THD=8\%$.

A. Adaptive HB control vs. Fixed HB control

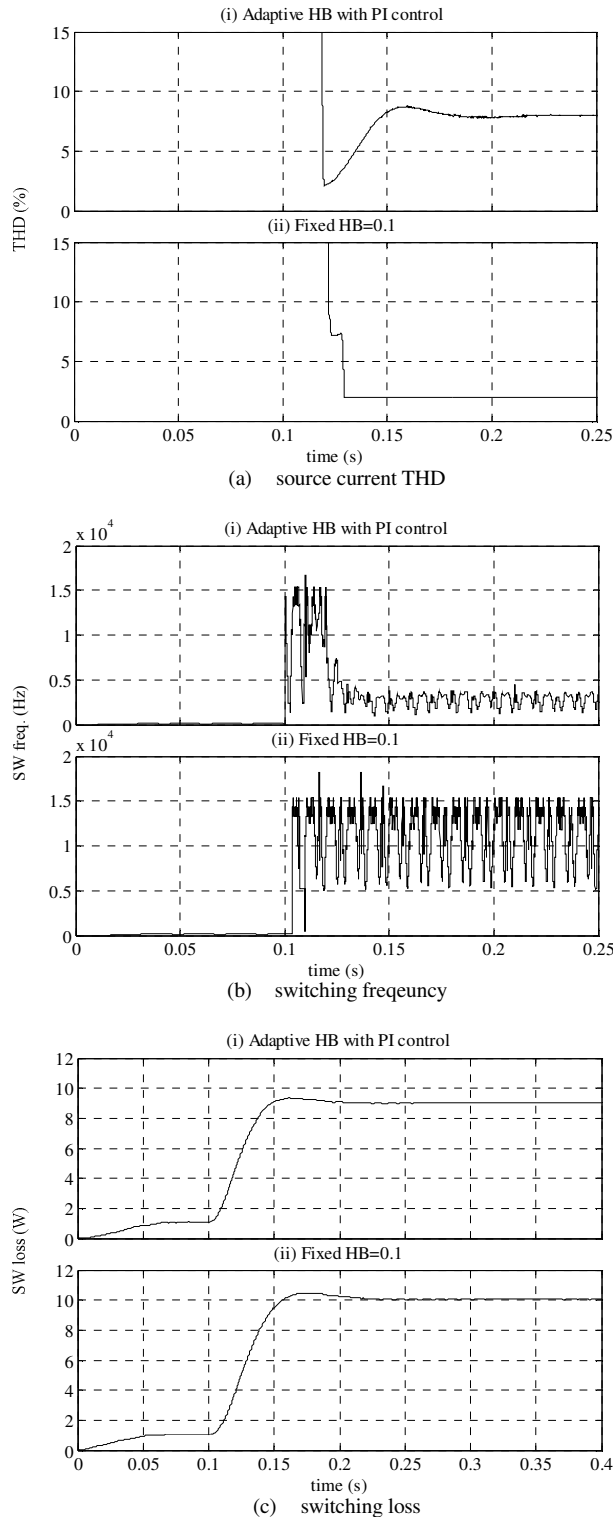

Figure 4. Comparison between adaptive HB and fixed HB control, (a) source current THD; (b) switching frequency; (c) switching loss.

TABLE III. SIMULATION RESULTS WITH DIFFERENT HB CONTROL

HB control	THD (%)	Max. SW freq. (kHz)	SW loss of each switching device (W)
Adaptive HB	8	4	9
Fixed HB=0.1	2	15	10

Fig. 4 shows the source current THD, switching frequency and switching loss comparisons between the adaptive HB with PI control and fixed HB control. Fig. 4(a) shows the source current THD, Fig. 4(b) shows the switching frequency and Fig. 4(c) shows the switching loss of one switching device waveforms respectively under (i) adaptive HB with PI control; (ii) fixed HB=0.1. The simulation results illustrate that even though the source current of HB=0.1 gives a better compensation performance with THD=2%, its maximum switching frequency is relatively high (max. at 15kHz), and provides a higher switching loss. When the proposed control method is applied, the switching frequency (max. at 4kHz) and switching loss are released with the desired source current THD (THD=8%). The corresponding simulation results are summarized in Table III.

B. PI control vs. Fuzzy logic control

In addition, the simulation results under (a) PI control and (b) fuzzy logic control are shown in Fig. 5 and Fig. 6. From Fig. 5 and Fig. 6, both control methods have the ability to track the reference current THD ($THD_{ref}=5\%$ and 8%). However, the performances of fuzzy logic control are better than that of PI control. The fuzzy logic control provides smaller overshoot, faster settling time, and smaller steady-state error, in which their performances are compared and shown in Table IV.

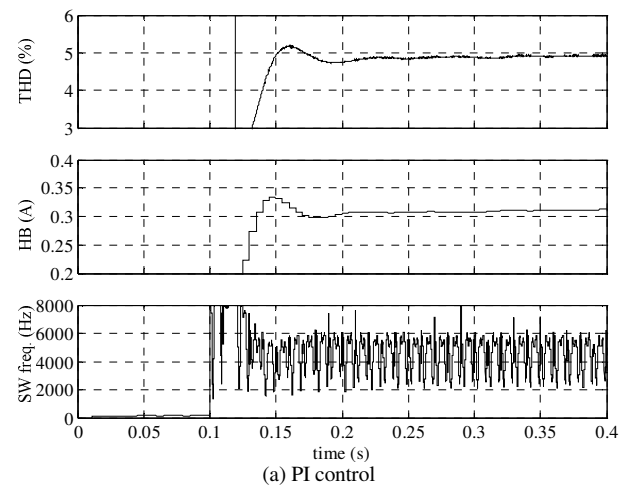

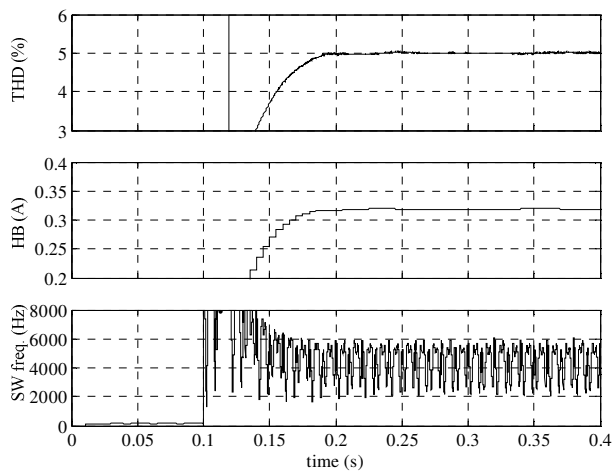

(b) Fuzzy logic control

Figure 5. source current THD, HB and switching frequency waveforms with reference $THD_{ref}=5\%$ under (a) PI control; (b) fuzzy logic control.

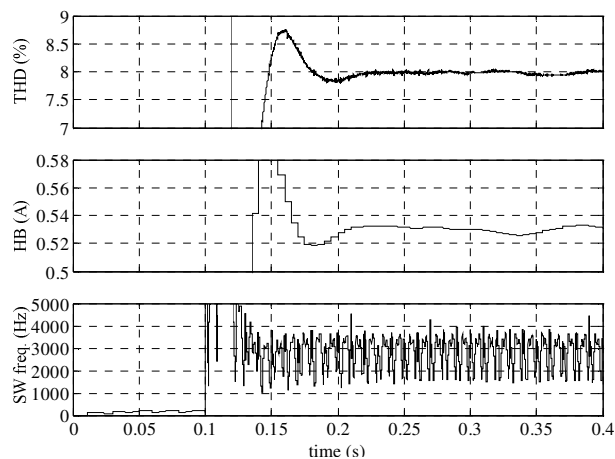

(a) PI control

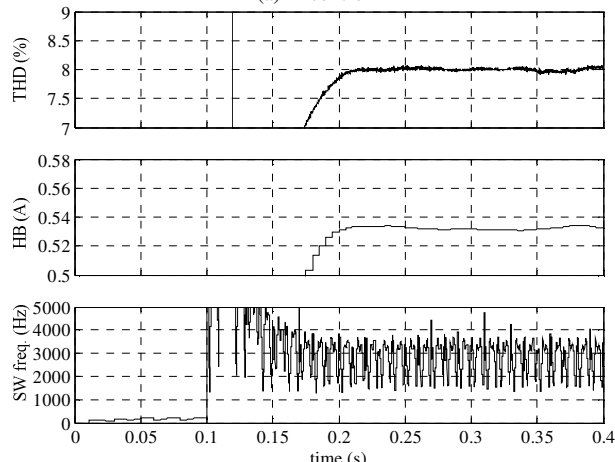

(b) Fuzzy logic control

Figure 6. source current THD, HB and switching frequency waveforms with reference $THD_{ref}=8\%$ under (a) PI control; (b) fuzzy logic control.

TABLE IV. SYSTEM PARAMETERS OF THE SIMULATION

Parameters	PI controller		Fuzzy controller	
	$THD_{ref}=5\%$	$THD_{ref}=8\%$	$THD_{ref}=5\%$	$THD_{ref}=8\%$
Percentage Overshoot (%)	3.6	9.4	1.6	2.5
Settling time (s)	0.362	0.203	0.2	0.204
Steady state error (%)	1.5	0.625	1.25	0.5

VI. CONCLUSION

In this paper, a 3-phase 4-wire 3-leg center split HPF with adaptive source current THD oriented fuzzy logic controller is proposed and verified by simulation. The controller adaptively changes the HB according to the source current THD reference value, so that the initial and operating costs of the HPF can be further reduced by releasing the switching frequency and switching losses of the switching devices. Comparisons between conventional PI and fuzzy logic control are studied; the fuzzy logic control demonstrates better dynamic and steady-state performances than the conventional PI control.

ACKNOWLEDGMENT

The authors would like to thank the Science and Technology Development Fund, Macao SAR Government and the research committee of University of Macau for their financial supports.

REFERENCES

- [1] J.S. Subjek, and J.S. Mcquilkin, "Harmonics-causes, effects, measurements and analysis," IEEE Transactions on Industrial Electronics, vol. 26, no. 6, pp. 1034-1042, Apr. 1990.
- [2] L.H.S. Duarte, and M.F. Alves, "The degradation of power capacitors under the influence of harmonics," IEEE Harmonics and quality of Power 10th Conference, 2002, vol. 1, pp. 334-339.
- [3] H.L. Jou, and K.D. Wu, "Novel power converter topology for three-phase four-wire hybrid power filter," IET Power Electronics, vol. 1, no. 1, pp. 164-173, 2008.
- [4] N.Y. Dai, M.C. Wong, and Y.D. Han, "Three-dimensional space vector modulation with DC voltage variation control in a three-leg center split power quality compensator," IEE Proceedings Electric Power Applications, vol. 151, no. 2, pp. 198-204, Mar. 2004.
- [5] H. Akagi, Y. Kanazawa, and A. Nabae, "Generalized theory of the instantaneous reactive power in three-phase currents," International Power Electronics Conference, 1983, pp. 1375-1386.
- [6] H. Akagi, S. Ogasawara, and K. Hyosung, "The theory of instantaneous power in three-phase four-wire systems: a comprehensive approach," IEEE Industry Applications Conference, 1999, vol. 1, pp. 431-439.
- [7] "IEEE Recommended Practices and Requirements for Harmonic Control in Electrical Power Systems," IEEE Standard 519-1992, 1993.
- [8] F. Mekri, B. Mazari, and M. Machmoum, "Control and optimization of shunt active power filter parameters by fuzzy logic," IEEE Transactions Electrical and Computer Engineering, vol. 31, no. 3, pp. 127-134, 2006.

- [9] F. Casanellas, "Losses in PWM inverters using IGBTs," IEE Proceedings Electric Power Applications, vol. 141, pp. 235-239, Sept. 1994.
- [10] M.C. Wong, J. Tang, and Y.D. Han, "Cylindrical coordinate control of three-dimensional PWM technique in three-phase four-wired trilevel inverter," IEEE Transactions on Power Electronics, vol. 18, no. 1, pp. 208-220, 2003.
- [11] B.K. Bose, "Expert system, fuzzy logic, and neural network applications in power electronics and motion control," Proceedings of the IEEE, vol. 82, no. 8, pp. 1303-1323, Aug. 1994.
- [12] S.K. Jain, P. Agrawal, and H.O. Gupta, "Fuzzy logic controlled shunt active power filter for power quality improvement," IEE Proceedings Electric Power Applications, vol. 149, no. 5, pp. 317-328, 2002.