

Design of LCL Filter for Harmonic Suppression in Co-phase Railway Power Quality Conditioner

Keng-Weng LAO, Man-Chung WONG, NingYi DAI, Chi-Kong WONG
Electrical and Computer Engineering
University of Macau Faculty of Science and Technology
Macao, China
yb17424@gmail.com

Abstract—LCL filter has been widely used for harmonic suppression in power system converter, especially at high power conditions. For instance, in the 27.5 kV locomotive co-phase traction power, the railway power quality conditioner is a back-to-back converter, and LCL filter is preferred to suppress the harmonics injected. In this paper, the design procedure of LCL filter for harmonic suppression in co-phase railway power quality conditioner is being analyzed and proposed. The influence of LCL filter parameter on its performance is being derived mathematically and discussed. Besides normal discussion of current harmonic suppression, voltage harmonic suppression performance of LCL filter is also investigated. Finally, the LCL filter design is being verified via PSCAD simulation. This paper provides a systematic design procedure for LCL parameter design, which is derived based on mathematical analysis.

I. INTRODUCTION

LCL filter has been commonly used for suppression of harmonic injection in switching converters [1-2]. Power electronics switching converters are normally connected in parallel or in series with the power system, and are mostly composed of switching components controlled by pulse width modulation (PWM) signals. Rapid switching causes frequent changes in the output current and voltage of the converter. Thus, a filtering circuit structure is usually adopted in the converter topology so as to reduce the harmonics injected into the power system.

Three common filtering structures in power electronics converters include L, LC and LCL circuits, which structure is shown in Fig. 1. It is mentioned in most researches that the harmonic suppression performance of LCL is the best among all [3-4]. Thus, it is recommended that LCL filter is applied whenever there is high requirement for harmonic suppression.

The installation of the world's first co-phase traction power compensation device in China Kunming signifies a new page of traction power supply topology for high speed railway. Railway power quality conditioner (RPC) in co-phase

traction power provides compensation of power quality problems, such as system unbalance, reactive power and harmonics. RPC is a back-to-back converter composed of electronic switches, which may generate harmonics into the power grid [5]. Therefore, filtering structure is required to minimize the injection of harmonics into the system.

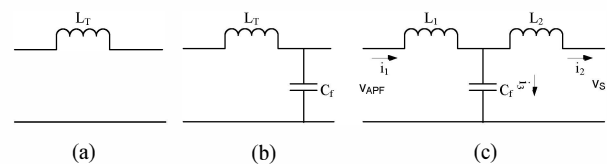

Figure 1 Circuit structure of (a) L; (b) LC; and (c) LCL filters

LCL filter may be used in RPC since traction loadings are considered to be large load in power system. However, so far in most researches, there is still lack of LCL filter parameter design analysis [6-7]. In this paper, the design of LCL filter parameter in co-phase traction power supply is analyzed. In section I, brief introduction of the paper is given. The circuit structure of LCL Filter in co-phase traction power supply with RPC is introduced in section II. Afterwards, the LCL filter structure is being modeled in section III. In section IV, the effects of LCL parameter design is being analyzed and discussed. PSCAD simulation verification results are presented in section V and a conclusion is summarized in section VI.

II. LCL FILTER IN CO-PHASE TRACTION WITH RPC

The circuit structure of co-phase traction power supply with RPC is shown in Fig. 2. Locomotive loadings are usually electrified with 27.5 kV AC power, and in co-phase traction power, all locomotive loadings are connected across one single phase so as to avoid the risk of phase mixing. Penalties will be applied for poor power quality; and thus, RPC is employed to provide power quality compensation and conditioning in co-phase traction power.

As introduced previously, RPC is composed of a back-to-back converter with electronic switches. During power quality compensation, active and reactive power absorption or injection is achieved by modifying the PWM signals which control the electronic switches. Frequent switching of the electronic switches will introduce ripples and harmonics into the system, which may affect the compensation performance. Therefore, filtering structure is required to attenuate the ripples and harmonics introduced by RPC in co-phase traction power supply system.

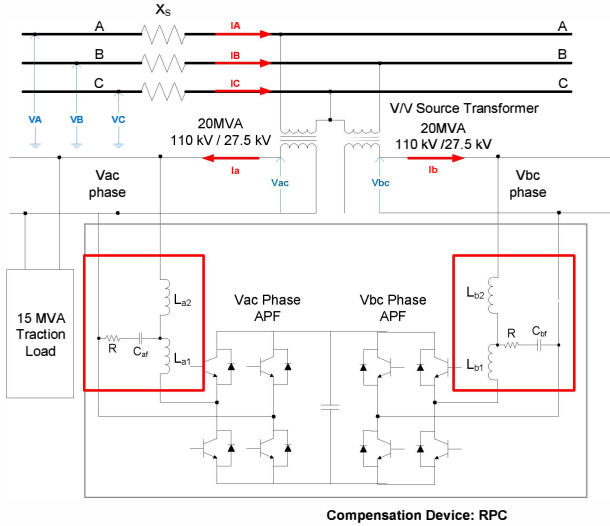

Figure 2 The circuit structure of LCL filter in RPC for providing power quality compensation in co-phase traction power.

Traction loadings are considered to be large load, and in order to suppress the harmonics introduced by RPC during compensation, LCL filter is adopted. As shown in the square boxes in Fig. 2, LCL filter is located between the point of common coupling (PCC) point and the output from the electronic switches. The modeling of LCL filter for analysis is presented in the next section.

III. MODELING OF LCL FILTER

In order to analyze the performance of LCL filter, the circuit of LCL filter is being modeled first using the circuit diagram in Fig.3. It is assumed that the RPC output V_{RPC} is processed using the LCL filter, formed by Z_1 , Z_2 and Z_3 . The impedance of the power grid side is then modeled by Z_L .

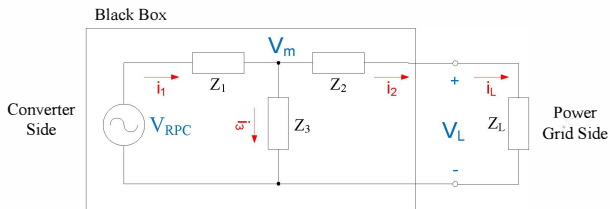

Figure 3 Circuit schematic of LCL filter used for modeling.

A. Thevenin's Equivalent Model

First of all, the LCL filter is modeled using Thevenin's theory. The famous Thevenin's equivalent model is shown in Fig. 4.

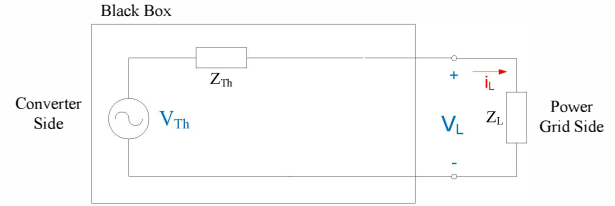

Figure 4 The Thevenin's equivalent model used for analysis.

The expression in (1) can be easily obtained by simple circuit analysis.

$$V_{Th} - i_L Z_{Th} = V_L \quad (1)$$

Similarly, the expressions in (2) can also be obtained from circuit analysis of Fig. 3.

$$\begin{cases} i_1 = \frac{V_{RPC} - V_m}{Z_1} \\ i_2 = i_L \\ i_3 = \frac{V_m}{Z_3} \\ i_1 = i_2 + i_3 \\ V_m = V_L + i_2 Z_2 \end{cases} \quad (2)$$

By further manipulation, the expressions in (3) and (4) are resulted.

$$\frac{V_{RPC} - V_L - i_L Z_2}{Z_1} = i_L + \frac{V_L + i_L Z_2}{Z_3} \quad (3)$$

$$\left(\frac{Z_3}{Z_1 + Z_3} \right) V_{RPC} - i_L \left(Z_2 + \frac{Z_1 Z_3}{Z_1 + Z_3} \right) = V_L \quad (4)$$

Comparing (1) and (4), the relationship in (5) can be observed. The value of Z_{Th} is also the equivalent impedance of the LCL filter in RPC.

$$\begin{cases} V_{Th} = \left(\frac{Z_3}{Z_1 + Z_3} \right) V_{RPC} \\ Z_{Th} = Z_2 + \frac{Z_1 Z_3}{Z_1 + Z_3} = Z_2 + Z_1 // Z_3 \end{cases} \quad (5)$$

In LCL filter (refer to Fig. 1), $Z_1=sL_1$, $Z_2=sL_2$, $Z_3=1/sC_f$. Assuming the RPC impedance is negligible, (6) can be obtained by substituting the relationship into (5). This is also the Thevenin's equivalent model of the LCL filter.

$$\begin{cases} V_{Th} = \left(\frac{1}{s^2 L_1 C_f + 1} \right) \cdot V_{RPC}(s) \\ Z_{Th} = sL_2 + \frac{sL_1}{s^2 L_1 C_f + 1} \end{cases} \quad (6)$$

B. Transfer Function

Next, the transfer function of the LCL filter is derived. The core equation of the transfer function can be determined by substituting the result obtained in (6) into (4), as shown in (7).

$$i_L(s) = \left(\frac{1}{s^3 L_1 L_2 C_f + sL_1 + sL_2} \right) \cdot V_{RPC}(s) - \left(\frac{s^2 L_1 C_f + 1}{s^3 L_1 L_2 C_f + sL_1 + sL_2} \right) \cdot V_L(s) \quad (7)$$

Since the function of the LCL filter is to suppress harmonics generated by RPC, it is worth investigating the transfer function between the output current and voltage at the power grid side and the RPC voltage. The relationship is obtained from simple arithmetic manipulations of (7) and is shown in (8) and (9).

$$\frac{i_L(s)}{V_{RPC}(s)} = \frac{1}{s^3 L_1 L_2 C_f + sL_1 + sL_2} \quad (8)$$

$$\frac{V_L(s)}{V_{RPC}(s)} = \frac{1}{s^2 L_1 C_f + 1} \quad (9)$$

The expression in (8) is the transfer function of LCL filter, which can be found in most studies and researches. It indicates the frequency response of the RPC voltage and the power grid side current (point of common coupling PCC). However, according to the expression in (7), the RPC voltage can also affect the power grid side voltage and the relationship is thus reflected in (9).

IV. EFFECTS OF LCL PARAMETERS ON PERFORMANCE

In this section, the analysis of the effects of LCL parameters on performance is explored according to the model developed above so as to propose a suitable design procedure.

First of all, let us have a deeper understanding of the LCL filter. The LCL filter is normally designed according to the

desired cutoff frequency for harmonic suppression. The expression in (10) can be obtained by rearrangement of (8).

$$\frac{i_L(s)}{V_{RPC}(s)} = \left(\frac{1}{s} \right) \cdot \left(\frac{\frac{1}{L_1 L_2 C_f}}{s^2 + \frac{L_1 + L_2}{L_1 L_2 C_f}} \right) \quad (10)$$

It can then be observed from (10) that the cutoff frequency ω_c is located at the point which (11) is satisfied.

$$\omega_c = \sqrt{\frac{L_1 + L_2}{L_1 L_2 C_f}} \quad (11)$$

It is suggested in researches that the total inductance, $L_T=L_1+L_2$, can be selected according to (12), in which V_{dc} is the DC voltage of the converter, f_s is the converter switching frequency and Δ_{ip} is the amplitude of the current ripple avoidable.

$$L_T = L_1 + L_2 = \frac{V_{dc}}{8\Delta_{ip} f_s} \quad (12)$$

However, there is little discussion on the distribution of L_1 and L_2 . The following analysis is developed based on these assumptions.

- The LCL filter is designed according to (11);
- The inductance ratio between L_1 and L_2 is a such that $L_1/L_2=a$ and $L_T=L_2(a+1)$;
- The cutoff frequency is located at k times of the fundamental system frequency such that $\omega_c=k\omega_s$

Afterwards, the effects of LCL filter parameter are discussed.

A. Effects on Equivalent Impedance

One may have wondered on whether the LCL filter will alter the designed impedance since (12) is derived based on inductive structure only.

By substituting $L_1=aL_2$ and (11) as well as the assumptions above into (6), the expression for the equivalent fundamental LCL impedance is obtained, as shown in (13).

$$Z_{Th} = (j\omega_s) \left(\frac{1}{a+1} \right) \left[\frac{a}{1-(1/k)^2(a+1)} + 1 \right] L_T \quad (13)$$

The graph of LCL filter impedance ratio with desired total impedance is plotted against the values of a and k in Fig. 5.

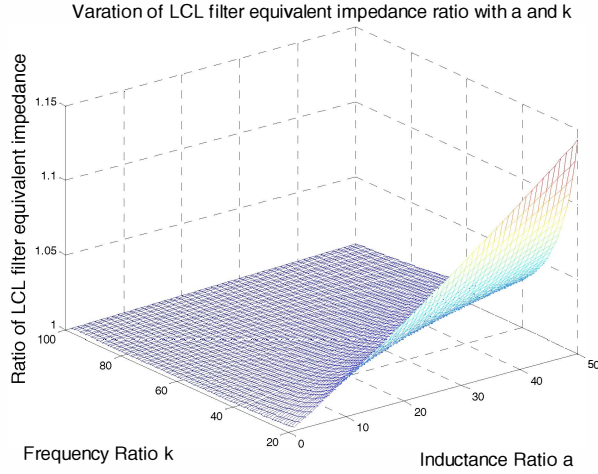

Figure 5 Three dimensional plot of the LCL filter equivalent impedance ratio with desired total impedance L_T against the values of ratio a and k .

The range of k is chosen as 20 to 100, which corresponds to cutoff frequency of 1 kHz to 5 kHz for a 50 Hz power system; while the range of a is chosen as 0.1 to 50. The followings can be observed from the figure.

- Under the condition being studied, there is no condition such that the LCL filter equivalent impedance is lower than the desired total inductance L_T ;
- The larger the value of a , the more is the derivation of the LCL equivalent impedance from desired total inductance L_T ;
- The derivation is not much (around 1 ~ 1.15); it is thus applicable when the inductance value does not affect the control of the converter.

Therefore, it may be concluded that the equivalent impedance of the LCL filter can be estimated by the total sum of the inductance within it.

B. Effects on Harmonic Suppression

As described, one major function of LCL filter is to suppress the harmonics generated by the converter. It is therefore essential to explore the effects of LCL parameters on harmonic suppression performance.

By substituting $L_1=aL_2$ and (11) into (8) and (9), the expressions in (14) and (15), which show the frequency response of the LCL filter current and voltage.

$$\frac{i_L(s)}{V_{RPC}(s)} = \frac{1}{s^3(L_T/\omega_c^2) + sL_T} \quad (14)$$

$$\frac{v_L(s)}{V_{RPC}(s)} = \frac{1}{s^2((a+1)/\omega_c^2) + 1} \quad (15)$$

It can be observed from (14) that the harmonic current suppression performance is dependent on the total inductance L_T and the cutoff frequency ω_c . Referring to (15), it can be inferred that the harmonic voltage suppression performance is dependent on the value of a and the cutoff frequency. In other words, the value of a does not affect the LCL filter harmonic current suppression performance, but will influence its harmonic voltage suppression.

In order to further investigate the effect of inductance ratio a on LCL voltage harmonic gain, a graph is plot in Fig. 6 according to (15). It can be observed from the figure that the voltage harmonic gain is higher with a lower inductance ratio a .

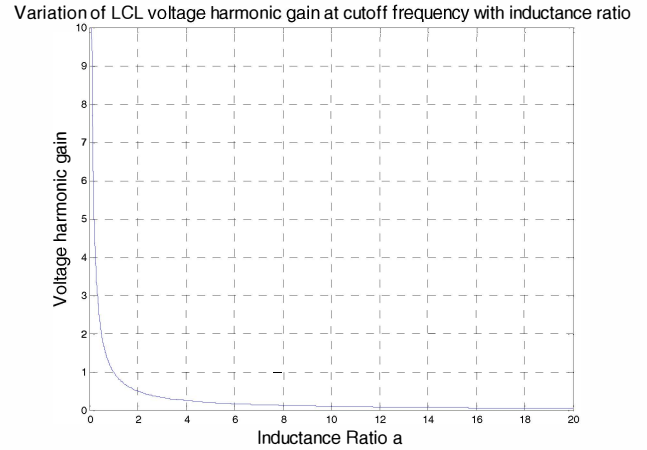

Figure 6 A graph showing the relationship of LCL filter voltage harmonic gain with inductance ratio a .

Therefore, based on the analysis, a higher value of inductance ratio a is preferred for suppressed harmonic voltage.

C. Effects on Capacitance Value

Finally, the effect of inductance ratio a on the LCL filter capacitance value is being explored. By substituting $L_1=aL_2$ into (11), (16) can be obtained. For easier analysis, the fraction containing the parameter a is defined as a new parameter k_c .

$$C_f = \frac{1}{\omega_c^2 L_T} \left(\frac{(a+1)^2}{a} \right) = \frac{1}{\omega_c^2 L_T} \cdot k_c \quad (13)$$

The graph of k_c against the variation of inductance ratio a plotted according to (13) is shown in Fig.7. It can be observed from Fig. 7 that with a fixed LCL filter capacitance value, there are two values of a which can satisfy the condition. Combining this idea with the conclusion from previous subsection, a higher value of a is desirable for better harmonic suppression performance. In case when a minimum capacitance value is desired, the value of a is best selected as 1.

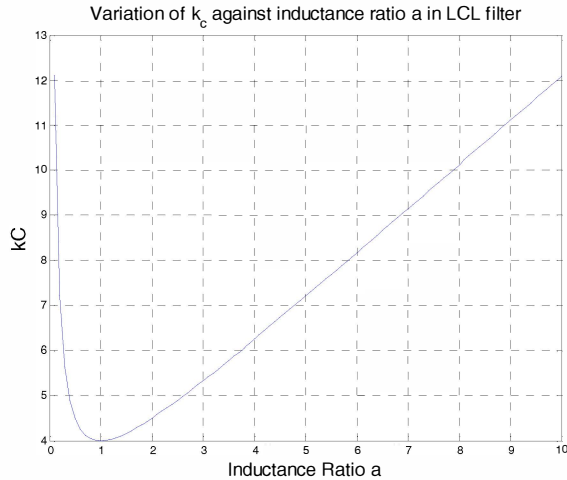

Figure 7 A graph showing the variation of k_c against inductance ratio a .

V. PROPOSED LCL FILTER DESIGN PROCEDURE

Two LCL filter design procedures are proposed below for different purposes based on the analysis above.

A. Design based on Capacitance C_f

First, assume that there is a desired capacitance value C_f , the LCL filter may be designed according to the followings

1. Select an appropriate cutoff frequency so as to determine the value of k in (11);
2. Design the total inductance L_T based on the current ripple avoidable and (12);
3. Choose the inductance ratio a ($L_1=aL_2$, $a>1$) according to C_f and (13)

B. Design based on minimum capacitance

Next, suppose that the condition which minimum capacitance is preferred. The following design procedure may be followed.

1. Select an appropriate cutoff frequency so as to determine the value of k in (11);
2. Design the total inductance L_T based on the current ripple avoidable and (12);
3. Choose inductance ratio $a=1$;
4. Calculate the required capacitance according to (13)

VI. SIMULATION VERIFICATIONS

After the discussions, analysis and proposing of the LCL filter design procedure, simulation verifications are done using PSCAD. The simulation circuit schematic is constructed according to Fig. 2. It is a co-phase traction power supply system with RPC. Supposing that a LCL filter cutoff frequency of 1 kHz is desired, the two LCL filter design proposed above are being simulated. In order to show the effectiveness of the LCL filter, simulations are also done with RPC using conventional L filter.

A. Design based on Capacitance C_f

Assume that a capacitance value C_f of 50 μF is desirable; the calculated parameters are shown in Table I.

TABLE I. Calculated Parameters based on Capacitance C_f

Parameters	Value
Desired capacitance C_f	50 μF
LCL filter cutoff frequency f_c	1 kHz
Frequency ratio k	20
Converter switching frequency f_s	10 kHz
Converter DC link voltage V_{dc}	41 kV
Current ripple avoidable Δi_p	35 A
Desired total inductance L_T	14 mH
Inductance ratio a	0.04 or 26

Different simulation results are presented below.

1) RPC with conventional L filter

Suppose that the co-phase RPC is using conventional L filter, with total inductance value of 14 mH, as calculated in Table I. The simulated three phase power grid voltage and current waveforms are shown in Fig. 8. It can be observed from Fig. 8 that the converter injects voltage harmonics into the system. This is also why conventional L filter is not preferred.

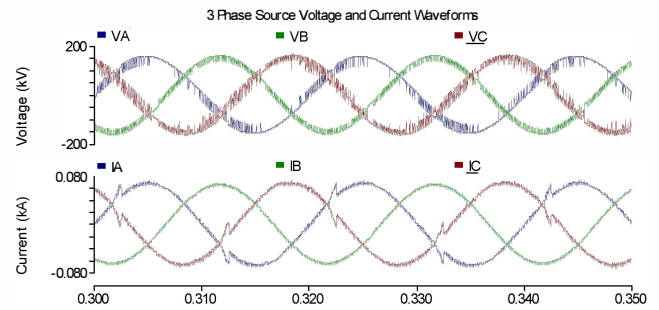

Figure 8 Simulated three phase source voltage and current waveforms obtained via co-phase traction power system with RPC using conventional L filter.

2) RPC with LCL Filter using Proposed Design ($a=26$)

Next, simulation results are obtained using RPC with proposed LCL filter design. According to the design, the condition with value of a larger than 1 is preferred and simulated waveforms are shown in Fig. 9. It can be clearly seen that in contrast with Fig. 8, the voltage harmonics introduced is less. This verifies the effectiveness of proposed LCL filter design in harmonic suppression.

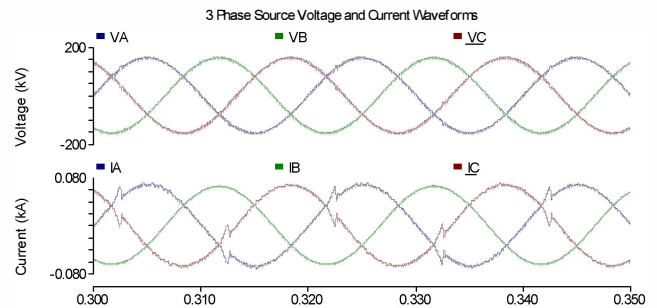

Figure 9 Simulated three phase source voltage and current waveforms obtained via co-phase traction power system with RPC using LCL filter with proposed design ($a=26$).

3) RPC with LCL filter ($a=0.04$)

In order to provide more comprehensive analysis, the other condition, which $a < 1$, in LCL filter design is also investigated. The simulated results are shown in Fig. 10. It can be observed that compared to Fig. 9, the voltage harmonics introduced is more. Therefore, with the same inductance and capacitance value, value of a higher than 1 can provide better harmonic suppression performance.

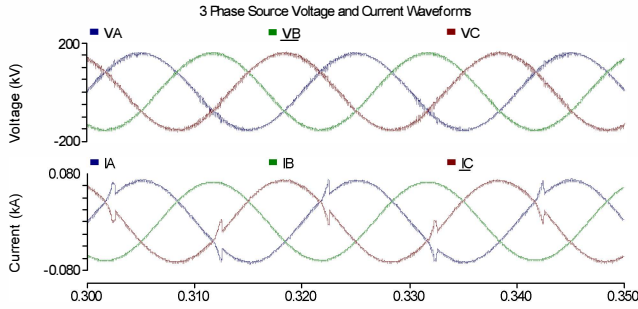

Figure 10 Simulated three phase source voltage and current waveforms obtained via co-phase traction power system with RPC using LCL filter ($a=0.04$)

Summarized simulation results are shown in Table II. It can be observed from the results that the harmonic suppression performance is better using LCL filter. With a higher value of a , the voltage harmonic suppression performance is better; while the value of a does not affect the current suppression performance. This then verifies the proposed LCL filter parameter design.

TABLE II. SUMMARIZED SIMULATION RESULTS

Parameters	Conventional L filter	LCL filter ($a=0.04$)	LCL filter ($a=26$)
Inductance L_1	7 mH	0.5 mH	13.5 mH
Inductance L_2	7 mH	13.5 mH	0.5 mH
Capacitance C_f	---	50 μ F	50 μ F
Voltage THD	10.2 %	3.10 %	1.64 %
Current THD	4.88 %	4.73 %	4.86 %

B. Design based on minimum capacitance C_f

Finally, the design of LCL filter based on minimum capacitance C_f . Based on the calculations in Table I, with value a of 1, the calculated C_f is 4 μ F.

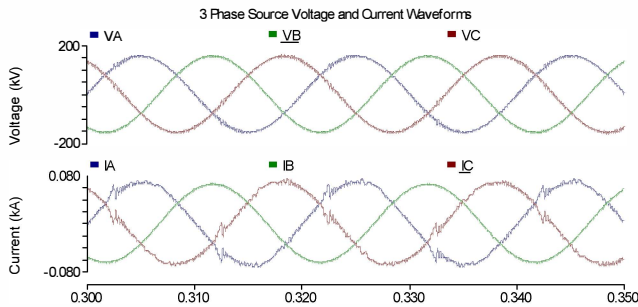

Figure 11 Simulated three phase source voltage and current waveforms obtained via co-phase traction power system with RPC using LCL filter ($a=1$, minimum capacitance C_f)

This is also most of the design used in researches and publications about LCL filter. The simulated results are shown in Fig. 11. The voltage and current THD are 2.49% and 5.0% respectively. Although the performance is also satisfactory, a higher damping resistance is required.

VII. CONCLUSION

To summarize, the design of LCL filter in co-phase traction power RPC for harmonic suppression is proposed in this paper based on the analysis of LCL parameter on performance. The equivalent impedance and transfer function of LCL filter is modeled first using Thevenin's theory. Afterwards, the effect of inductance ratio a , which $L_1 = aL_2$, in LCL filter is explored. It is found that the value of a does not cause significant changes in the equivalent impedance of the LCL filter. It is also discovered that the value of a does not affect the current harmonic suppression performance but will affect the performance on voltage harmonic suppression. To sum up, a higher value of a is preferred. Two LCL filter design procedures are proposed in this paper, with one based on fixed capacitance, and another based on minimum capacitance value. The LCL filter design is then verified via simulations of a co-phase traction power supply system with RPC. It is shown that with proposed LCL filter parameter design, it can provide better harmonic suppression performance in the power system.

VIII. ACKNOWLEDGEMENTS

The authors would like to thank the Science and Technology Development Fund (Project Code No: 015/2008/A1), Macao SAR Government and Research Committee of University of Macau (Project Code No: MYRG137(Y1-L4)-FST-WMC) for their financial support.

REFERENCES

- [1] Yi Tang ; Poh Chiang Loh; Peng Wang; Fook Hoong Choo ; Feng Gao; Blaabjerg, F., "Generalized Design of High Performance Shunt Active Power Filter With Output LCL Filter", *IEEE Transactions on Industrial Electronics*, Volume: 59, Issue: 3, pp: 1443- 1452, 2012
- [2] Sangin Lee ; Kui-Jun Lee ; Dong-seok Hyun, "Modeling and control of a grid connected VSI using a delta connected LCL filter", *34th Annual Conference of IEEE Industrial Electronics, IECON 2008*, pp: 833 – 838, 2008.
- [3] Weimin Wu ; Yuanbin He ; Tianhao Tang ; Blaabjerg, F., "A New Design Method for the Passive Damped LCL and LLCL Filter-Based Single-Phase Grid-Tied Inverter", *IEEE Transactions on Industrial Electronics*, Volume:60, Issue: 10, pp: 4339 – 4350, 2013
- [4] Petterson, S. ; Salo, M. ; Tuusa, H., "Applying an LCL-filter to a four-wire active power filter", *37th IEEE Power Electronics Specialists Conference, PESC '06*, pp: 1-7, 2006.
- [5] Keng Weng Lao, Ning Yi Dai, Wei Gang Liu, Man Chung Wong, "Hybrid power quality compensator with minimum DC operation voltage design for high-speed traction power systems", *IEEE Transactions on Power Electronics*, Vol. 28, No. 4, April 2013, pp. 2024-2036.
- [6] Peng Zhan ; Weixing Lin ; Jinyu Wen ; Meiqi Yao ; Naihu Li, "Design of LCL filters for the back-to-back converter in a Doubly Fed Induction Generator", *IEEE Innovative Smart Grid Technologies - Asia (ISGT Asia)*, 2012.
- [7] Yao Xin-li ; Luo Long-fu ; Xu Jia-zhu ; Liao Wen-di, "LCL output filter design and the influence to the D-STATCOM compensation characteristic", *2011 International Conference on Electronics, Communications and Control (ICECC)*, pp: 313-316, 2011